

# Phantom Cell Architecture for LTE and its Application in Vehicular IoT Environments

Hatim Lokhandwala<sup>1</sup>, Vanlin Sathya<sup>1,\*</sup>, Bheemarjuna Reddy Tamma<sup>1</sup>

<sup>1</sup>Department of Computer Science and Engineering, Indian Institute of Technology Hyderabad, India.

Proliferation of Internet of Things (IoT) devices (smart wearables/vehicles, etc.) in the near future, would raise the capacity and bandwidth demands from the cellular infrastructure manifold. Deploying small cells is an effective solution to cope with the problem. This work focuses on a special kind of small eNBs, termed as Phantom eNBs. Phantom eNB acts as a supplement to the current radio access network (RAN) in the LTE infrastructure. It handles the data plane while a Macro eNB holds the control plane. Definitions of control and data plane, along with the modifications needed in the protocols stack are explained in this paper. Communication mechanisms are developed for Phantom and Macro eNB to communicate over the X2 interface between them. NS-3 simulations are performed for handover scenarios of Vehicular IoT environment, consolidating the architecture and network topology designed for Phantom based Heterogeneous Networks (HetNets). Network throughput improvements of 80% and 14% are observed in comparison to the Macro-only RAN and existing small cell solutions (Femto cells), respectively.

Received on 09 May 2015; accepted on 08 July 2015; published on 10 July 2015

**Keywords:** Control Plane, Data Plane, IoT, LTE, Macro eNB, Phantom eNB, MeNB, PeNB, UE.

Copyright © 2015 V. Sathya *et al.*, licensed under ICST. This is an open access article distributed under the terms of the Creative Commons Attribution license (<http://creativecommons.org/licenses/by/3.0/>), which permits unlimited use, distribution and reproduction in any medium so long as the original work is properly cited.

doi:10.4108/ue.2.5.e5

## 1. Introduction

The Internet of Things (IoT) can be characterized by interconnection of uniquely identifiable physical entities. IoT comprises of connection and communication among millions or even billions of devices and objects. An entity in IoT could be any physical unit ranging from human beings to automobiles [1] (cars, buses, trains), electrical devices (fans, bulb, etc.), smart phones, power meters, civil structures (buildings, bridges), etc. These entities generally have following capabilities [2]:

- **Sense:** Measuring some phenomena like temperature, humidity, or blood pressure.
- **Communicate:** Transmitting the processed data to a destination server.
- **Process:** Processing the sensed data according to the context of application.

IoT requires advanced techniques for connectivity of devices, systems and services and is the next big challenge for communication networks. It exposes a complete new set of applications, protocols and

domains. IoT is foreseen as a basic building block for the vision and development of smart cities in the future. Under the concept of smart city [3], myriads of IoT applications are possible in diverse fields like health care [4], home and industrial automation [5], transport systems [6], energy consumption, retail management, logistics and supply chain, environment monitoring [7, 8], governance, etc.

Vehicular IoT is one such IoT application which aims for smart transport systems [6] typically for vehicles on road networks. Traffic congestion is one of the serious problems on road networks. It results in increased vehicular queuing, slow movement of vehicles and thus longer trip times. It is generated owing to a greater demand than the capacity of a road or of intersections along the road. Traffic jams occur when vehicles on the road stop for a long amount of time. Traffic jams and congestion cause commuters to incur significant losses in terms of their time and money.

Deployment of sensors inside the vehicles [9] and realizing IoT paradigm adds significant intelligence to the transport system. Vehicular IoT addresses and

Corresponding author Email: [cs11p1003@iith.ac.in](mailto:cs11p1003@iith.ac.in)

resolves many of the day-to-day challenges faced by the commuters in the existing road networks. Information gathered through various categories of sensors deployed inside the vehicles can be utilized for different sets of applications. Data from a large pool of vehicles can be accumulated and processed on the cloud. This would facilitate gathering of various statistics associated with transport systems of different geographical areas, thus enabling real-time decision making. Traffic on different routes can be determined through Global Positioning System (GPS) data received from vehicles in real-time. One could then plan the journey along a route with least traffic to the destination. Medical facilities can be provided at times of emergency and accidents. Also, since every vehicle has its own identity, identifying nearby public vehicles like cabs, taxis and others would be easy for local citizens and visitors from a different place. If the need be, one can call the driver of the vehicle for picking one up at one's location. IoT in transportation system helps in monitoring various real-time situations by integrating sensing, processing and communicating capabilities in physical objects like cars and buses. This adds a significant value in the lives of the citizens providing them with a better and a safer travel experience.

However, one of the most challenging aspects in Vehicular IoT is the communication of data from the sensors in the vehicles to a remote location (typically a server located on Internet). Existing 4G (LTE) cellular infrastructure could be utilized as a medium of communication in Vehicular IoT. Here the aggregated sensor data from the vehicles could be transmitted to the cellular base stations and then, communicated further. However in modern times, there has been a tremendous increase in the use of smart phones, tablets and other new mobile devices which support a wide variety of applications. Cisco VNI Mobile Forecast (2013) states that 79% [10] mobile data usage is because of smart-phones and tablets. Further, mobile data is expected to register a tremendous growth of almost 11 times in the coming years, reaching 18 exa-bytes per month by the end of 2018. The number of mobile users would rise from 4.1 billion in 2013 to around 5 billion by 2018. Also mobile video will account for 69% [11] of all mobile data by 2018, up from about 53% in 2013. Evolution of IoT in the near future would further bring forward a new breed of devices like smart-wearables, smart-vehicles, smart-manufacturing units, smart home appliances, etc. A survey [12] by an industry analyst firm, IDC, predicts that the installed base for IoT will grow roughly to 212 billion devices by 2020 [10]. They foresee that this growth would be largely driven by intelligent systems installed for collecting/aggregating data, across both consumer and enterprise applications. Presently LTE networks are being deployed worldwide

for providing higher data rates and lower latency than the existing 2G/3G networks. But considering the above statistics where there is an increase in the number of mobile users and also the traffic from Vehicular IoT, in the near future, even LTE networks would not be able to satisfy the demands. Thus, we need to explore new ways to support the increasing capacity demand and the hunger for higher data rates.

Vehicular IoT being an outdoor application, traditional indoor solutions based on Wi-Fi, small cells called Femto cells [13, 14] and in-building cells using distributed antenna systems, are not suitable. Existing approaches for outdoor environments include deployment of Femto cells [13] to satisfy the increasing demands. However in outdoor scenarios, users are expected to be mobile and these Femto cell networks typically incur a lot of signaling and handover overheads and thus are not suitable for many applications including Vehicular IoT [15, 16]. Demand in this context is two-fold:

- Cater to the bandwidth requirements of millions of vehicles.
- Mobility of vehicles has to be taken into account and hence there is a need for communication infrastructure which would provide seamless connectivity with vehicles incurring minimum signaling and handover overheads.

In [17], authors suggest deployment of small eNBs called Phantom eNBs on a high frequency band (i.e., 3 GHz or more) as frequency bands till 2.5 GHz are fully occupied. In the Phantom cell concept, the control plane (C-plane) and data plane (D-plane) are split amongst Macro eNB (MeNB) and Phantom eNB (PeNB) [The terms MeNB/Macro eNB and PeNB/Phantom eNB are used interchangeably across the paper]. Under this scenario, the C-plane is supported by a continuous reliable coverage layer offered by Macro eNBs at lower frequency bands and the D-plane is provided by Phantom eNBs at higher frequency bands. The terms Phantom cell and Macro cell denote the coverage area under Phantom eNB and Macro eNB, respectively. Thus the heterogeneous network comprising of Phantom eNBs and Macro eNBs is referred to as Phantom HetNet or Phantom based HetNet. In this kind of HetNets, a user equipment (UE) maintains dual connectivity with Macro and Phantom eNBs. Release 12 from 3GPP [18] illustrates about the concept of dual connectivity. Under this, a UE can be connected to both the Macro eNB and the small eNB and the control and the data transfer takes place through both of them. However, our work focuses on a special case of the dual connectivity mechanism from 3GPP, wherein C-plane and D-plane of a UE are connected to a Macro eNB and Phantom eNB, respectively. Figure 1 shows an architecture of

Phantom HetNet comprising of Macro eNBs in which one of Macro eNBs is having three Phantom eNBs under its coverage region.

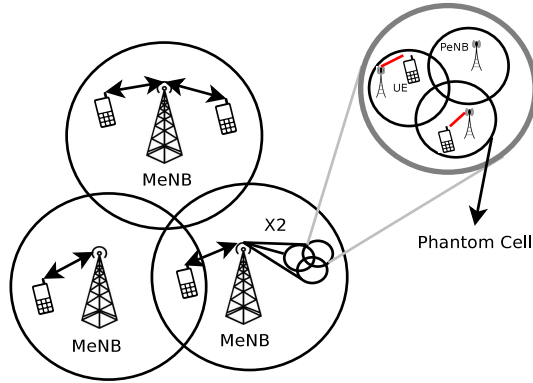


Figure 1. An Architecture of Phantom based HetNet.

Phantom cell capitalizes on the existing LTE network infrastructure and offers good support for mobility. In a Phantom HetNet, MeNB acts as the centralized controller for multiple PeNBs under its coverage region. The cooperation of PeNB and MeNB relies on the X2 interface. The X2 interface between PeNB and MeNB can be realized through a dedicated point-to-point connection as mentioned in [17].

In [19], we focused on the realization of Phantom HetNets in LTE. Performance analysis of the system was done mainly for static scenarios with sparse deployment of Phantom eNBs. This work focuses primarily on the evaluation of system performance in mobility scenarios. In that context, we consider the application of Phantom HetNets in Vehicular IoT. Realistic situations are taken into account which reflect conditions on a typical road network. Also, dense deployment of Phantom eNBs is considered in order to facilitate handovers between them. This helps in performing a comparison study of the following network systems: Macro only LTE networks, Femto based HetNets and Phantom based HetNets.

The rest of paper is organized as follows. Section 2 illustrates application of Phantom HetNets in Vehicular IoT environments and highlights some generic benefits of this kind of HetNets. Section 3 presents certain major architectural challenges associated with different network entities and their communication in this Phantom HetNets. In Section 4, we give a detailed explanation on the UE protocol stack, initial cell acquisition and synchronization procedure when a UE gets connected with both Macro and Phantom eNBs in a Phantom HetNet. Protocol stack of Phantom eNB, random access and paging mechanisms for Phantom HetNets are also covered in Section 4, addressing the challenges described in the previous section. Section 5

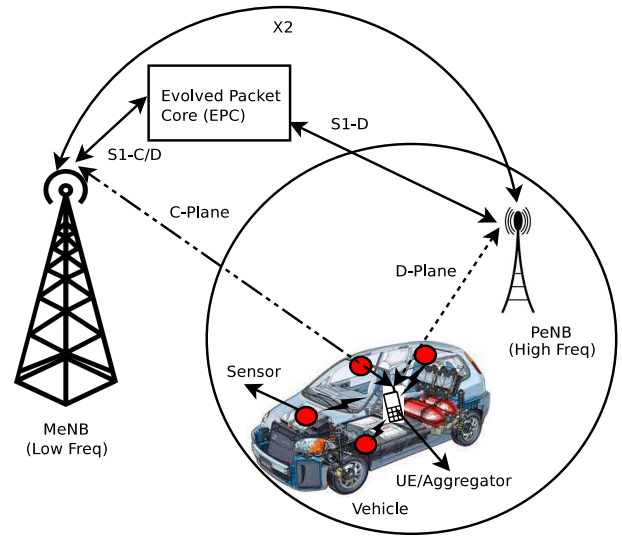


Figure 2. C-plane/D-plane Split among Macro and Phantom eNBs.

presents mobility scenarios illustrating the shift of D-plane to and from, between Phantom and Macro eNBs. In Section 6, we describe an experimental setup depicting Vehicular IoT scenarios, utilizing the Phantom and other network systems and then present comparison results. Finally, Section 7 presents conclusions and directions for future work.

## 2. Motivating Application and Generic Advantages of Phantom HetNets

Vehicular IoT is one of the potential applications that could benefit from Phantom HetNets. Figure 2 represents a situation in which a vehicle is equipped with various types of sensors and an Aggregator/UE is aggregating data from all the sensors in the vehicle. UE is connected to a Phantom eNB for sensor or user data transfer (D-plane) and to a Macro eNB for control (C-plane). Phantom eNB is connected to the Evolved Packet Core (EPC) only through S1-D interface while Macro eNB is connected to the EPC through S1-C/D interfaces.

Figure 3 depicts a scenario in which Phantom eNBs are deployed along the road side for serving users and IoT enabled vehicles passing along the road. Phantom eNBs provide connectivity to the devices/users under its range and in scenarios where a device/user does not fall in the range of any of the Phantom eNBs, then it is handled by Macro eNB for both the control and data transfer. In this Phantom HetNet, there would be less handover overhead [20, 21] as there would be a mere D-plane shift from one Phantom eNB to other while the C-plane is still handled by the same Macro eNB. Below we highlight some of the potential benefits of Phantom cells.

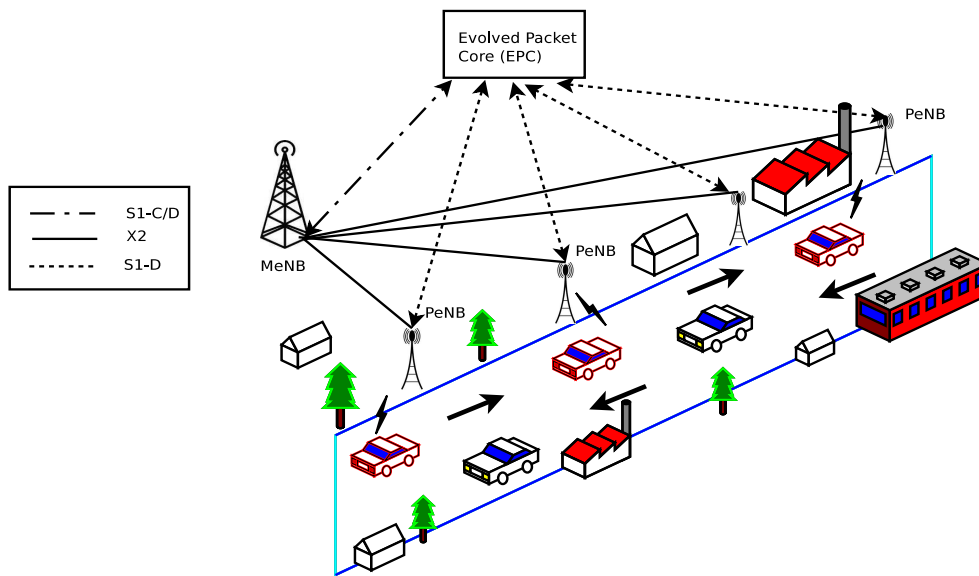


Figure 3. Phantom based HetNet serving UEs and IoT devices.

## 2.1. Advantages of Phantom Cells

- Typically Macro and Phantom eNBs have different operating frequencies and hence there would be no cross-tier interference among them. This is of notable benefit as integration of Phantom cells would not impact the functioning of the legacy Macro cell networks where the cellular operators have already made huge investments.
- Phantom eNBs can be incorporated into the existing cellular networks without requiring any re-arrangement of Macro eNBs.
- Flexibility to turn the Phantom eNBs ON/OFF, depending upon the traffic levels at different times during a day. This could result in substantial energy savings [22, 23] and thereby reduce OPEX for the telecom operators.
- Reduction in control signaling owing to less frequent handovers because of the centralized handling of the C-plane at a Macro eNB.
- Deployment can be done according to the traffic requirements. Sparse deployment would be apt in normal traffic areas, for e.g. in small parks etc., whereas dense deployment could be done in hotspots for e.g. malls, airports, tech parks, railway stations, etc. In the context of Vehicular IoT, dense deployment would be preferable on busy roads and sparse deployment would work on roads with lesser traffic.

## 3. Control and Data Plane Split: Major Challenges

Phantom eNBs, unlike the conventional Macro eNBs, will only send primary/secondary synchronization signals (PSS/SSS) and will not send cell specific reference signals, Master Information Block (MIB) and System Information Blocks (SIBs) in the LTE frame structure. The Radio Resource Connection (RRC) procedures between a UE and the Phantom eNB such as channel establishment ( $RRC_{Connected}$ ), channel release ( $RRC_{Disconnected}$ ) and  $RRC_{Idle}$  are all maintained by the Macro eNB on behalf of the Phantom eNB, with which the UE will get attached. Also, the authentication of UE for attachment with Phantom eNB is done by Macro eNB.

### 3.1. Challenges:

Below we highlight potential challenges in Phantom HetNets for obtaining and maintaining parallel connections with two eNBs.

1. A major challenge is in facilitating the communication of a UE with both eNBs simultaneously as MeNB and PeNB operate at different frequency bands. Switching to and fro from one frequency band to another could be one remedy for this. However, this is not efficient as it would result in decreased throughput and increased communication delays with each of the two eNBs.
2. Time synchronization of a UE with both the eNBs so as to facilitate proper data transfer.

3. Besides the regular control messages exchanged in the process of channel establishment, handovers and other mechanisms, mere data transfer between a UE and the eNB involves exchange of control messages such as acknowledgments, scheduling grants and scheduling decisions, etc. Therefore separating and categorizing the components of the control and data planes and specifying a definitive boundary between them is a challenging task.
4. Mobility management: UEs are mobile typically and sometimes they may not be necessarily in the coverage of a Phantom eNB. Under such scenarios, a Macro eNB has to hold both the control and data planes of the UEs.
5. Energy conservation is another concern that needs to be addressed. UEs and aggregators in general are battery powered. Simultaneous communication at two different frequency bands would result in utilization of two radios which may severely impact the battery usage. Hence efficient communication mechanism needs to be developed in such cases.
6. Sparse deployment of Phantom eNBs may lead to scenarios in which certain Phantom eNBs are overloaded. In that case, on the arrival of new UEs appropriate decisions have to be made so as whether to connect the UE
  - (a) to Macro eNB for both C-plane and D-plane or
  - (b) to connect to a Macro eNB for control and to a Phantom eNB in the vicinity of the overloaded Phantom eNB for D-plane.

For the above provisions to be made, the UE protocol stack has to be modified. Also the above structural changes have to be taken into account during the functioning of layers in the protocol stack of Phantom eNB and Macro eNB and a means for communication over the X2 interface has to be implemented. In the sections that follow, a procedure has been suggested for the architecture of each of these different segments, and the solutions to the above challenges.

## 4. Protocol Stack of Phantom UE, Phantom eNB and Initial Cell Acquisition Procedure

### 4.1. Protocol Stack of Phantom UE (UE connected to both Macro and Phantom eNB)

Presently, a UE resonates at a certain frequency of a band/channel, typically of the 2.1 GHz spectrum, for its operation and communication. But UEs must be able to

work at two different frequency bands for transmission to and reception from the Macro and Phantom eNBs simultaneously while communicating in these HetNets, where Phantom eNBs generally operate at 3GHz or more. One solution is to add an additional radio in the UE, this however would increase the circuit design complexity and the cost. Carrier aggregation [24–26] offers a very promising solution for Phantom UEs to handle both traffic (C-plane and D-plane) from different frequency bands with a single radio interface. Phantom radio interacts through the MAC layer and higher layers of the traditional LTE-UE stack. Moreover, these layers maintain state information of the Phantom mode of the UE (where UE is connected to a Phantom eNB for the data and a Macro eNB for the control) or Macro mode of the UE (where everything goes through Macro eNB). Depending upon the topology and the mobility, a UE may or may not be connected to Phantom eNBs. It is, thus, necessary to store the state information at the higher layers.

### 4.2. Initial Acquisition/Synchronization procedure with Phantom and Macro eNBs

When a UE is switched on, a cell acquisition procedure is performed to identify the cells nearby that can be connected to and know the configurations of the cell in order to communicate with them. UEs attempt to get the Primary Synchronization Signal (PSS) from Macro and Phantom eNBs (in the vicinity), and acquire the physical cell layer identity (PCID) and sub-frame timing (5 ms) of the two cells. Next, the UE finds the Secondary Synchronization Signal (SSS), and is able to get the cell identity group and frame timing of the cells. In [17], it was suggested that there should be no PSS/SSS from Phantom eNB. An approach to this could be that the Phantom eNB instead, indirectly send the PSS/SSS through Macro eNB through the X2 interface between them. This would however incur a lot of communication delay and is a highly in-feasible and unscalable approach.

After receiving the PSS/SSS, UE gets the Master Information Block (MIB) from the Macro eNB. MIB carries the information about system bandwidth, number of antennas in eNB side, Frame information, etc., for every 40ms in physical broadcast channel (PBCH). However, there would be no MIB from Phantom eNB and instead, the Phantom eNB would communicate all information about the MIB to Macro through the X2 interface. Generally, following information is included in an MIB from the Macro eNB:-

1. Downlink bandwidth of Macro.
2. System Frame Number.

As the Phantom eNBs do not transmit any MIB, the MIB of the Macro eNB is modified in the

free reserved bit slot so as to include the downlink bandwidth of the Phantom eNB. Hence with the MIB from Macro eNB, UE gets to know the downlink bandwidth of the Phantom eNBs as well. Similarly, Phantom eNBs also do not transmit any system information block (SIB) (SIBs are transmitted for every 80ms in physical downlink shared channel (PDSCH)). So the SIB-2 received from Macro, normally containing the uplink bandwidth of Macro eNB, would now also include the uplink bandwidth of Phantom eNBs. Similarly, all the system information, including the configuration details present in SIBs 1-9 from the Macro eNB, would also include the system information for Phantom eNBs which are sent to a Macro eNB through the X2 interface. The advantage of using MIB and SIBs in centralized controller (i.e., Macro eNB) is, it can reduce the signaling overhead messages from Phantom eNBs and save bandwidth of PDSCH that can be better used for data transmission by Phantom eNBs. Thus, if the signal strength of a Macro eNB is higher than that of a Phantom eNB, a UE would be connected only to the Macro eNB for both the control and data traffic. And if the UE gets a better signal strength from the Phantom eNB, the UE would be attached to it for data transfer on a higher frequency band.

### 4.3. Protocol Stack of Phantom eNB

Phantom eNBs provide high scalability by providing flexibility to network operators to gradually add capacity. Its deployment can be done according to requirements and it need not be uniform in all cases. The layers in the protocol stack of Phantom eNB would be the same as that in the Macro eNB but with certain modifications to their functionality. A Phantom eNB is connected to, just the P-GW and there is no connection formed with the MME (Mobility Management Entity) as shown in Figure 2. In any case, a UE would be connected to a Macro eNB and all NAS (Non-Access Stratum) messages for authentication of the UE would go to that Macro eNB. If a UE is connected to Phantom eNB for data transfer, Macro eNB would share the information of authentication with the Phantom eNB through the X2 interface. All the signaling radio bearers (SRBs) which transmit the RRC and NAS messages, are sent by the Macro eNB. Phantom\_NAS as shown in Figure 4 would only store the information for the authentication of UE, and no message exchange happens between MME and the UE to authenticate the UE. Likewise, Phantom\_RRC layer keeps the information of the establishment of the RRC context. The sub-sections that follow specify two main mechanisms performed by Macro eNB on behalf of the Phantom eNBs to aid the data transfer mechanism.

**Random Access and RRC Connection Setup.** In Phantom HetNet, UE can maintain dual connectivity with two

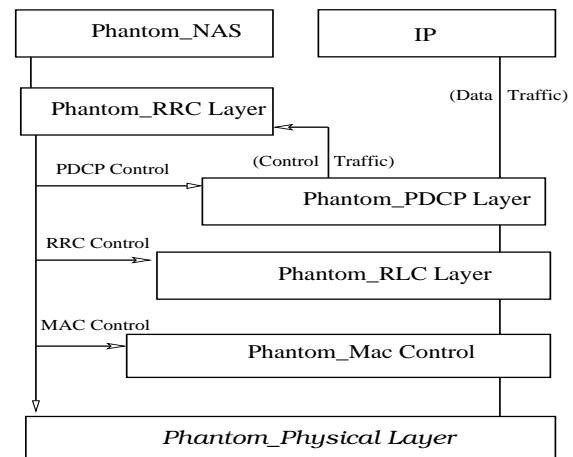


Figure 4. Protocol stack of Phantom eNB.

different eNBs and the mechanisms to setup random access and RRC connections are quite different. A Macro eNB maintains the information about UE's connection state, i.e., if it is responsible for the control or for both the control and data traffic of the UE. RACH procedure between UE and Macro eNB takes place as usual for the exchange of control information from higher layers of the UE and Macro eNB. For the exchange of data between UE and Phantom eNB RACH procedure goes as mentioned hereafter. During the random access by the UE, one of the preambles is selected and transmitted over PRACH to the Macro eNB. Since the Macro eNB knows about the dual connectivity of UE, it passes this random access request to the appropriate Phantom eNB, with which the UE is connected, through X2 interface as shown in Figure 5. Phantom eNB then assigns a temporary C-RNTI and determines the timing advance for the UE using the location information of the UE provided by the Macro eNB (In dual connectivity the location/timing can be estimated using single Macro eNB PRACH preamble). This response is returned to the Macro eNB which in turn informs the UE over DL-SCH.

Further, the Macro eNB assigns resources to the UE for transmitting RRC connection request in the next step. In the third step, the RRC connection request is sent via UL-SCH with the resources assigned in prior step. The contention resolution is sent to the UE by the Phantom eNB via Macro eNB (Figure 5). Note that in the first step, many UEs may be performing simultaneous random accesses, probably using the same preamble sequence which would return the same temporary identifier in second step. In the fourth step, UE matches the identity in the message with the identity received at the second step. A UE upon confirming the match, completes the random access successfully and the data transfer would take place via Phantom eNB.

Redirection of the Random Access request to Phantom eNB by Macro eNB and the advantage of the presence of Phantom eNB, is that every Phantom/Macro eNB would have its own collision domain and this would reduce the collision probability.

Consider the case wherein a UE connects only to a Macro eNB and another UE connects to Phantom and Macro eNBs. Assume that they happen to use the same preamble while making their random access requests. Both the UEs can still successfully transmit the data. This is because the preamble of UE connected to the Macro eNB would go normally and the preamble of the UE connected to both the eNBs would go to Phantom eNB and thus the collision on picking the same preamble is avoided.

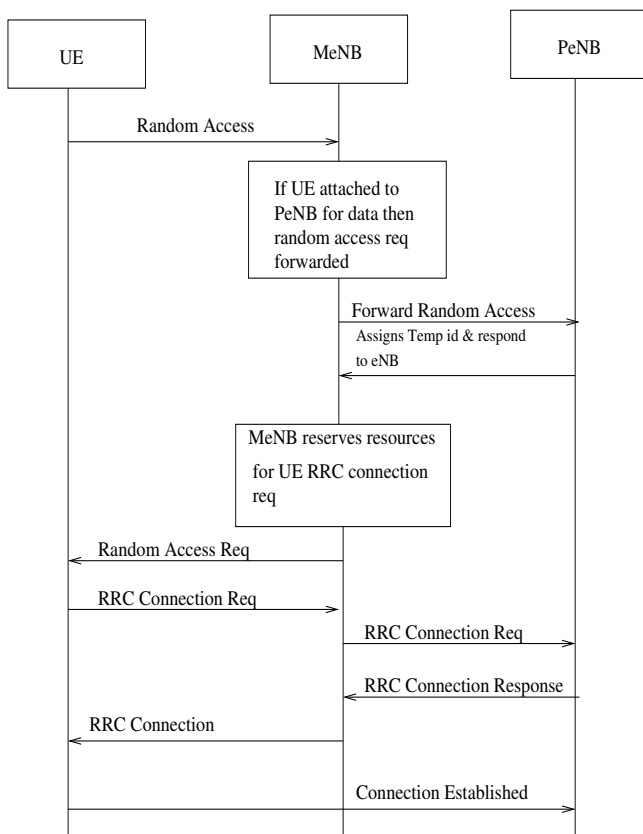


Figure 5. Call Flow Diagram for Random Access in Phantom based HetNets.

**Paging Mechanism:** Paging is a network initiated connection setup mechanism when there is some downlink data to be sent to UEs. A UE is informed of some incoming data through this mechanism. In LTE, S-GW first gets the downlink data and then acquaints MME about the incoming data. Now in Phantom HetNets, Phantom eNB is not connected to the MME and hence it does not send any of the paging messages. As only Macro eNB is connected to the MME, MME

informs all Macro eNBs in its tracking area about the paging messages. Macro eNB configures at which subframes a UE should wake up and listen to paging. A UE searches for P-RNTI in the paging message received through PDCCH of the UE\_physical layer. UE then looks for the identity information (P-RNTI) included in the paging message, by decoding PD-SCH from the information in the PDCCH. If UE determines it to be matching with its own identity then it triggers random access procedure followed by the RRC connection setup establishment. Thus we conclude that Macro eNB eventually aids the data transfer process by performing paging and RRC connection/Re-connection establishment procedures while actual data transfer takes place directly between UE and its associated Phantom eNB.

Phantom and Macro eNBs protocol stack thus needs to have mechanisms to communicate with each other over the X2 interface for the above mentioned procedures to take place.

## 5. Handover Scenarios in Phantom HetNets

In Phantom HetNets, there is an advantage of having a centralized controller (at Macro eNB) which has complete information of the topology and configuration of all Phantom eNBs under its coverage area. Also there would be a substantial reduction in signaling messages being exchanged during handovers because of the Macro eNB controlling the entire handover procedure [27-29]. In this context the following mobility scenarios could arise :-

### 5.1. Macro eNB to Phantom eNB Handover

UE is currently connected to the Macro eNB for both the control and data transfer when it is at location X as shown in the Figure 6. Macro eNB advertises location of Phantom eNBs under its coverage area through SIBs. Now in Figure 6 when UE is at location Y, it is in the coverage area of a Phantom eNB and also it starts getting good signal strength from that particular Phantom eNB. UE reports about this to the Macro eNB. Macro eNB acts as a controller and decides about the attachment of the UE to Phantom eNB based on the quality of signal, UE is receiving from that Phantom eNB. If it decides to attach UE to Phantom eNB, it then instructs the appropriate Phantom eNB through X2 interface to handle the new UE and also informs the UE, which then starts communicating with the Phantom eNB at a higher frequency. Hence, the UE would now get attached to the Phantom eNB for the data transfer and to the Macro eNB for the exchange of control messages as shown in Figure 6.

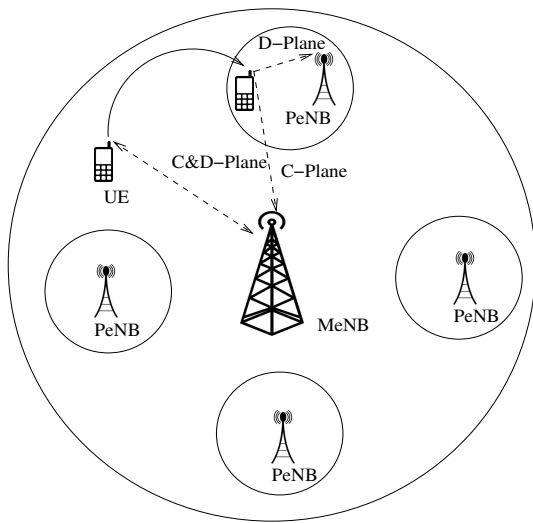


Figure 6. Macro eNB to Phantom eNB Handover in Phantom based HetNets.

### 5.2. Phantom eNB to Macro eNB Handover

This scenario is exactly the reverse of previous one where a UE moves out of the coverage area of a Phantom eNB and the Macro decides to handle the UE for both the control and data traffic. It instructs the UE and the Phantom eNB to release the resources currently allocated to the UE.

### 5.3. Phantom eNB to Phantom eNB Handover

Under this scenario, UE moves from the coverage area of one Phantom eNB to another Phantom eNB. Figure 7 depicts a topology with various PeNBs under the coverage of a MeNB. In the figure, UE moves in clockwise direction from location X → Y → Z → A and so on. During the movement of UE, handover takes place from one PeNB to other. However, there is only D-plane connection shift between PeNBs and control information still comes from the same MeNB.

Figure 8 shows the call flow diagram for phantom eNB to phantom eNB handover. PeNB1 and PeNB2 in the figure refers to two Phantom eNBs and MeNB in the figure refers to Macro eNB. As can be seen in the figure, UE is initially attached to the PeNB1 for data transfer in both uplink and downlink and is attached to MeNB for exchange of control information. UE periodically transmits A2, A4 measurement reports to the MeNB. Based on the reports from UE, MeNB then makes the decision of handover of the data plane to a new Phantom eNB. MeNB then issues RRC Disconnected procedure to PeNB1 which further initiates it with the UE. Meanwhile RRC connected procedure is initiated with the PeNB2 which then establishes the connection with the respective UE. Among all the mentioned scenarios Phantom eNB to

Macro eNB handover has the least overhead in the handover process as compared to other two scenarios outlined here.

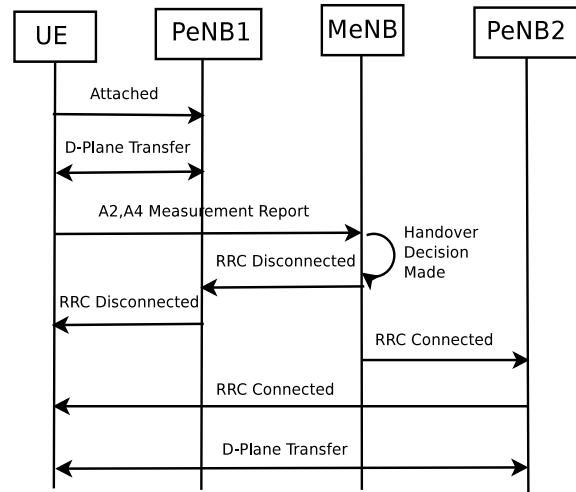


Figure 8. Call Flow Diagram for Phantom eNB to Phantom eNB Handover.

Further, parameters such as the current load on potential PeNBs could be taken into account while selecting the target PeNB. For this, in the handover scenarios of Sections 5.1 and 5.3, current load on a certain Phantom eNB can be incorporated as a decisive factor before performing the handover of the UE to that target Phantom eNB. Drastic increase in the number of UEs/vehicles may sometimes generate circumstances under which certain Phantom eNBs be heavily loaded, as they have small coverage areas. In that case, attaching a UE to the overloaded Phantom eNB may degrade the network throughput. Thus, for the handover scenario of 5.1, it would be beneficial to retain the attachment of UE to the Macro eNB for both control and data transfer rather than performing the handover to an overloaded Phantom eNB for data transfer. Similarly for the scenario in Section 5.3, it would be beneficial to attach the UE

- to a Macro eNB for both control and data transfer or
- to a nearby Phantom eNB of the overloaded Phantom eNB for data transfer and Macro eNB for control transfer.

rather than attaching it to the overloaded Phantom eNB. Macro eNBs can maintain the information regarding the load on different Phantom eNBs under its control. This information can be utilized during handover decisions. Apart from this, Cloud computing could also play a crucial role in such scenarios, where in the information regarding the load on different Phantom and Macro



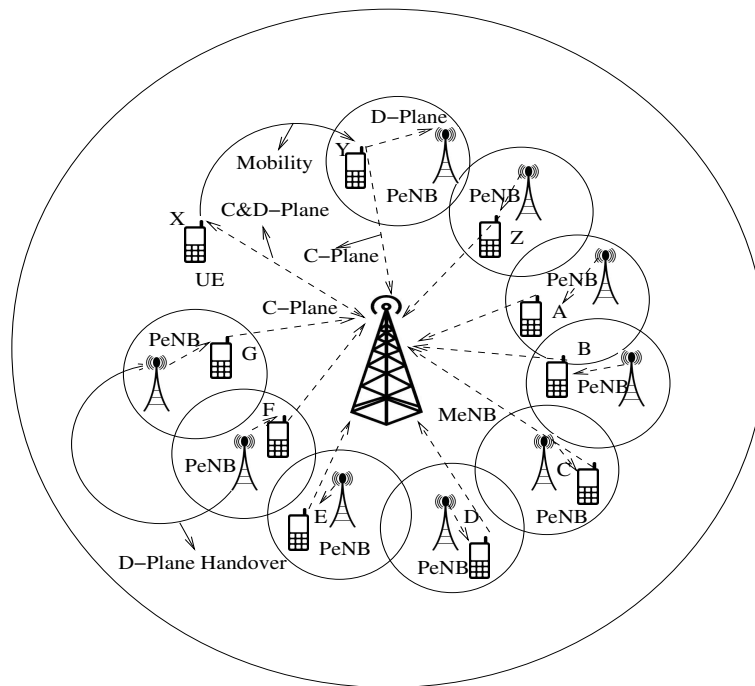


Figure 7. Phantom eNB to Phantom eNB Handover in Phantom based HetNets.

eNBs can be offloaded to the cloud in real-time. Macro eNBs can be connected to the cloud for updating the real-time information and receiving decisions of computations performed on the cloud. Mobility of the UE/vehicle can be another crucial factor to be considered during handovers. When UEs/vehicles are highly mobile, in that case they may undergo frequent handovers. This may impact the ongoing data transfer and effectively the network throughput. Macro eNB could thus make optimizations and avoid unnecessary handovers in high mobility scenarios.

## 6. Performance Evaluation

The proposed Phantom HetNet system is realized in NS-3.21 simulator [30] by extending it as per the requirements. Certain assumptions have been made which are in accordance with the latest 3GPP Release (Release 12 [26]). Additional modules and functionality have been added to the current modules provided by the simulator for LTE. Parameter configurations for simulations are listed in Table 1.

### 6.1. Experimental Setup

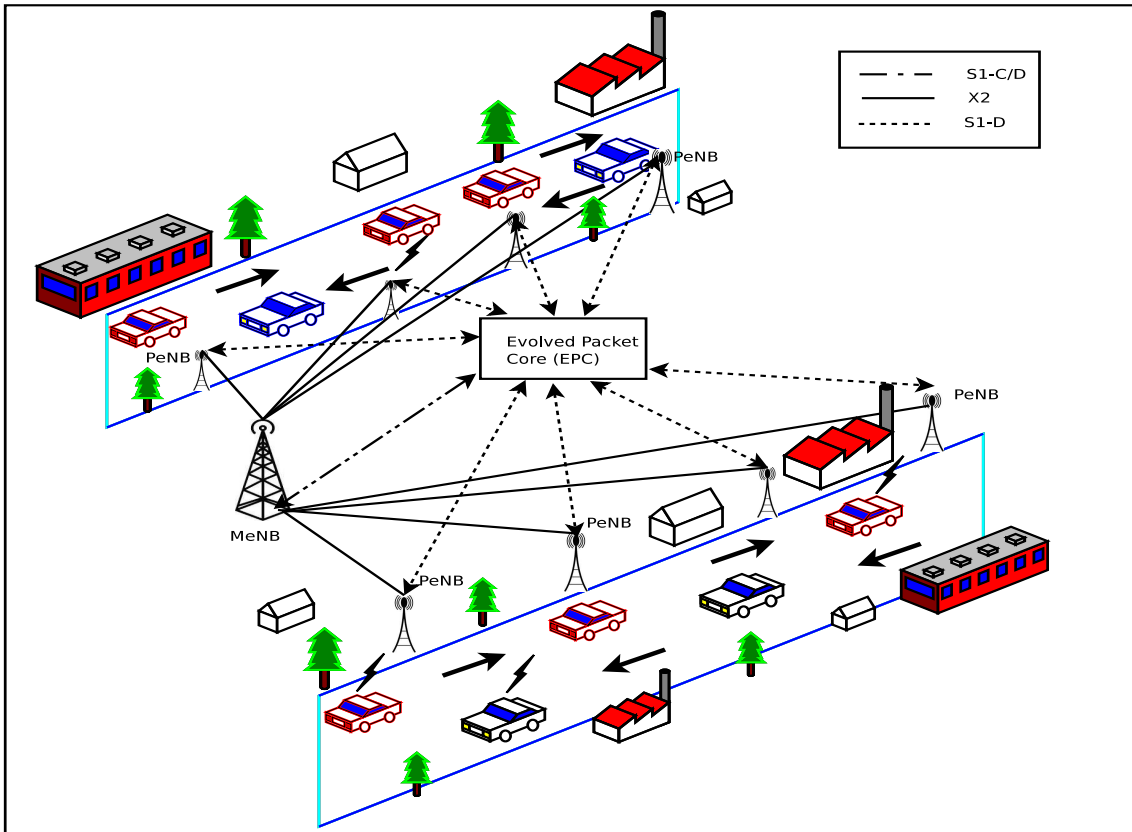
#### Mobility Scenario:

Consider a 3-dimensional coordinate system where  $x$  and  $y$  coordinates represent the location on 2-D space and  $z$  coordinates represent the height of the entities in 3-D space. Also notations such as  $+x$ ,  $-x$ ,  $+y$ ,  $-y$ ,  $+z$  and  $-z$  have their standard meanings where '+' represents the positive axes and '-' represents the negative axes.

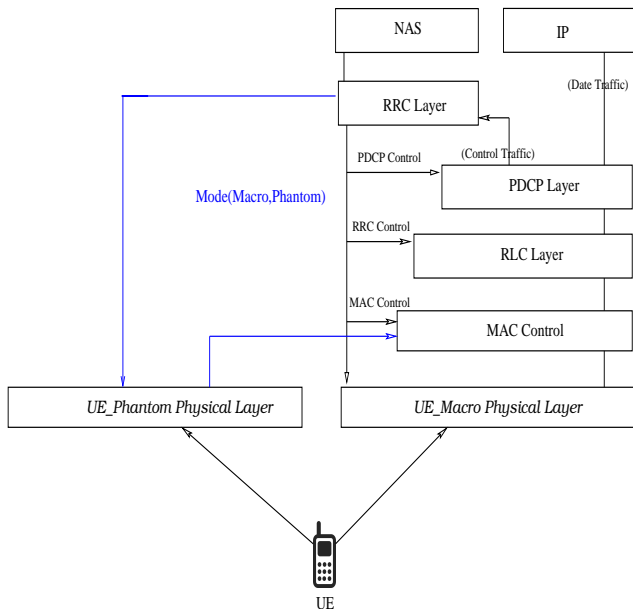
Table 1. NS-3 Simulation Parameters

System Parameters	Values
Operating Freq. of Macro eNB	700 MHz
Operating Freq. of Femto eNB	2100 MHz
Operating Freq. of Phantom eNB	2100 MHz
Building dimensions	4m × 4m × 20m
Macro eNB height	30m
Phantom eNB height	5m
Macro transmit power	46 dbm
Phantom/Femto transmit power	23 dbm
Vehicle Velocity	3 km/h, 30 km/h and 60 km/h
UE velocity	0.3 km/h
UE maximum transmit power	0.2W
Traffic direction	Uplink/Downlink
Handover Algorithm	A2-A4-RSRQ
Scheduling Algorithm	Proportional Fair
LTE Mode	FDD
System Bandwidth for eNBs	5 MHz (25 RBs)
Simulation Time	100 sec

In order to facilitate communication of UE with two different eNBs (Macro and Phantom eNBs) operating at different frequencies we added an extra physical layer in our NS-3 implementation. Figure 9 represents the protocol stack of extended UE for Phantom HetNets. UE\_Phantom Physical Layer in the Figure 9 is used for communication with Phantom eNB while UE\_Macro Physical Layer is used to communicate with Macro



**Figure 10.** Experimental Setup depicting a real time scenario of a road network comprising various network entities and surrounding environment. Vehicular IoT Traffic and Regular UEs being served by Phantom based HetNets.



**Figure 9.** Protocol Stack of Phantom UE.

eNB. Simulation experiments are performed for the following network configurations:

**Configuration (a):** This configuration depicts the Macros only network. Macro eNBs are deployed at the following locations:

- **Macro eNB 1:** (0, 2200, 30)
- **Macro eNB 2:** (0, 1300, 30)
- **Macro eNB 3:** (0, 400, 30)
- **Macro eNB 4:** (0, -500, 30)
- **Macro eNB 5:** (0, -1400, 30)

Here the z-coordinate represents the height of the Macro eNB (i.e., 30m). 20 UEs (vehicles) are placed on either side of these Macro eNBs. 10 of which are placed on +x axis and the remaining 10 on -x axis. Locations of the vehicles on the +x axis are as follows:

1. (300, i, 1) where  $i = j * 5$  [  $1 \leq j \leq 5$  ]
2. (300, 800-i, 1) where  $i = j * 5$  [  $1 \leq j \leq 5$  ]

Similarly locations of the vehicles on the -x axis are as follows:

3.  $(-300, i, 1)$  where  $i = j * 5$   $[1 \leq j \leq 5]$
4.  $(-300, 800-i, 1)$  where  $i = j * 5$   $[1 \leq j \leq 5]$

Vehicles belonging to categories 1 and 3 defined above are made to move in the direction of +y axis and those belonging to categories 2 and 4 move in the direction of -y axis. Thus, vehicles in category 1 and 3 move from the coverage of Macro eNB 3 towards coverage of Macro eNBs 2 and 1. While vehicles belonging to categories 2 and 4 move from the coverage of Macro eNB 3 towards coverage of Macro eNBs 4 and 5. Neither Femto eNBs nor Phantom eNBs are deployed in this scenario.

**Configuration (b):** This configuration depicts a Femto based HetNet comprising of Femtos and Macro eNBs. Macro eNBs and vehicles are placed at similar locations as in configuration (a). Additionally, 60 Femto eNBs are deployed. 30 of them lie on +x axis and the rest on the -x axis. Coordinates of the Femto eNB for the following setup are as follows:

1.  $(300, i * 60, 5)$  where  $[1 \leq i \leq 30]$
2.  $(-300, i * 60, 5)$  where  $[1 \leq i \leq 30]$

The z-coordinate represents the height of Femto eNB (i.e., 5m).

**Configuration (c):** This configuration depicts a Phantom based HetNet consisting of Macros and Phantom eNBs. Macro eNBs and vehicles are placed at locations as in configuration (a). Phantom eNBs are deployed at similar coordinates and with same height as those of Femto eNBs in configuration (b).

The idea behind setting up above network topologies comprising of vehicles and eNBs is to replicate a real-world scenario on a road network. Figure 10 represents a scenario with 2 roads on either side of a Macro eNB. Certain number of Phantom eNBs are deployed along the road sides which have connectivity with the Macro eNBs through X2 interface. Macro eNB connects to the core network via both S1-C/D interfaces while Phantom eNB connects merely through S1-D interface. Roads in the Figure 10 fall within the coverage of the deployed Macro eNB and as in actual conditions roads could be anywhere in the coverage of a certain eNB. Configuration (c) in the experimental setup aims to simulate the topology and deployment of entities as expressed in Figure 10. Presence of civil structures such as buildings and factories have also been taken into consideration for simulation purpose by placing these structures at appropriate locations. This covers the aspects of drop in signal strength caused to the existence of various obstacles in the surrounding environments of a particular UE/vehicle. Vehicles are also kept at a distance of 300m from the Macro eNB to realize the situation in which they are moving on roads near the cell edge of a particular Macro eNB.

Now with respect to Figure 10, in configuration (b) Phantom eNBs along the roadside are replaced by Femto eNBs. However, Femto eNBs have both S1-C/D connectivity to the core network and are connected to the Macro eNB via the Femto gateway. Configuration (b) is setup in order to obtain the performance of the existing small cell solutions (Femto cells) in mobility scenarios. Configuration (a) represents an existing LTE network comprising of regular Macro eNBs and there are no small eNBs along the road side for this configuration. Placement of Femto and Phantom eNBs in configuration (b) and (c) results in the formation of a Femto HetNet and Phantom HetNet, respectively in the region of +y axis. However, the region in the -y axis for configurations (b) and (c) is covered only by Macro eNB and forms the legacy Macro only network. This goes in analogy with the situation where in we have dense deployment of small cells in high traffic areas, while low traffic regions are covered by the regular Macro eNBs.

Simulations are run for each of the above described topologies. In each of the cases, vehicles are made mobile with the following distinct velocities: 3 km/h, 30 km/h and 60 km/h [26]. In all of the scenarios, TCP flows are installed over each of the vehicles to transfer 1 MB of data from the vehicle to a Remote Host connected over the Internet and vice versa. Consider for example, if we have 2 vehicles, then TCP flows are installed between each of the vehicle and the Remote Host in both uplink and downlink direction as shown in Figure 11. TCP flows are also installed among groups of 5 vehicles in a cyclic manner. Consider Figure 12, for example, which depicts a group of 3 vehicles and the way TCP flows are installed on them. Direction of the arrow in the figure is from TCP client to TCP server and thus each vehicle in the cycle acts as a client for one flow and a server for some other flow. Results are gathered over 5 different seed values for different vehicle velocities in each of the above configurations. Relevant statistics associated with each of the flows in every configuration are then computed and reported here.

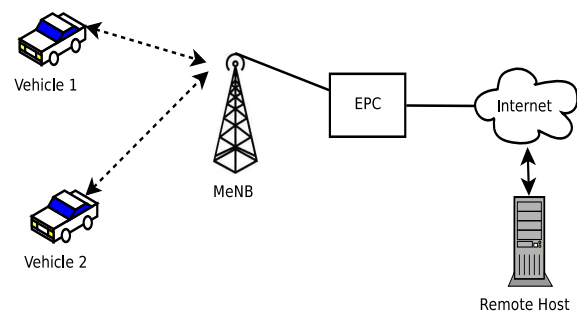


Figure 11. TCP Flow Between UEs/Vehicles and Remote Host.

In our previous work [19], we focused mainly on evaluating the system performance using Phantom

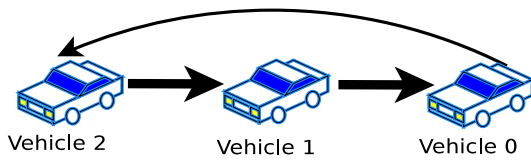


Figure 12. TCP Flow among UEs/Vehicles.

HetNet for static UEs. Moreover, the simulation setup done previously had lesser number of UEs and eNBs (Macro/Femto/Phantom) and the topology setup did not convey a realistic situation. Deployment of small cells (Phantom/Femto) was sparse with no overlapping regions. Also the UEs were placed in near proximity (at a distance of 20m) to the Macro eNBs. In general, UEs in proximity observe a better throughput due to use of higher modulation schemes and a poor throughput is observed for UEs near the cell edge due to larger distance and interference from the neighbouring cells. Current setup ensures that vehicles are along the cell edge and they continue to be along the edge even during their movement in the simulations. Along with that, in the prior [19] experimental setup Femto eNBs were made to operate at a frequency similar to that of Macro eNB. However, the Phantom eNBs operate at a higher cellular frequency. Thus in order to have a fair comparison between existing small cell solutions (Femto eNBs) and our approach (Phantom eNBs), we configure Femto eNBs on a higher operating frequency in the present simulations. Hence, there will not be any cross-tier interference between Macro cells and small cells (Femto/Phantom).

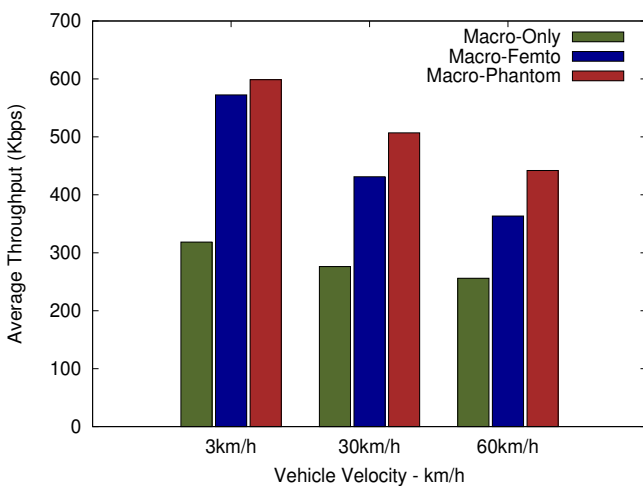


Figure 13. Throughput Comparison for different network configurations.

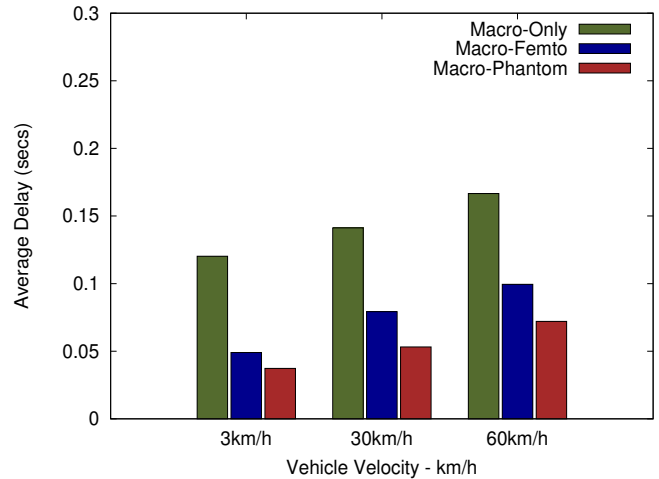


Figure 14. Delay Comparison for different network configurations.

## 6.2. Metrics

The following metrics are considered for performance evaluation:

- **Throughput:** The amount of data transferred from one device to other device in a given period of time. It is typically measured in units of bits per second (bits/s).
- **Delay:** Delay is the time taken for a packet to travel from one device to other device and is measured in fractions or multiples of seconds.
- **Average Throughput of System:** Sum of throughput values for all the flows in the network divided by the number of flows where in a flow represents a single TCP connection or a session between a pair of devices.
- **No. of Handovers:** The term handover refers to the process of transferring an ongoing call or data session (D-Plane) from one eNB (Macro/Phantom/Femto), connected to the core network to an another eNB.
- **No. of Signaling Messages:** The term signaling refers to the messages like MIB, SIB, RRC\_Connected(), RRC\_Disconnected() and RRC\_Idle(). The process of transferring these control signal messages will vary from Phantom HetNet to Macro and Femto HetNet.

One of the prime objectives is to improve the overall system throughput of the LTE network by deploying Phantom eNBs in the network. We expect that such Phantom HetNets offer higher capacity compared to the Macro only and Femto based HetNets. But the main concern is mobility as Vehicular IoT

being an outdoor IoT application. In this regards, we aim at reduction in the number of signaling messages exchanged, thus lesser handover overheads [20, 21], at increasing vehicle velocities.

### 6.3. Performance Results

**Mobility Scenario:** For configuration (a) in the experimental setup, vehicles get connected to the Macro eNB. However, in configuration (b) vehicles get better signal strength from Femto eNBs and hence get attached to Femto eNBs for their communication. Similarly in configuration (c), vehicles get connected to the appropriate Phantom eNBs for the data traffic and Macro eNB for the control traffic. Average of throughput and delay values of TCP flows in all the configurations mentioned in the mobility scenario with different vehicle velocities are calculated. Figure 13 and 14 illustrate the difference in the value of these metrics among the legacy Macro only network, Macro-Phantom HetNet and Macro-Femto HetNet for velocities of 3 km/h, 30 km/h and 60 km/h.

A 25% increase in throughput and an 80% increase in throughput are observed in Macro-Femto HetNet configuration and Macro-Phantom HetNet configuration, respectively with respect to Macro only setup at the velocity of 3 km/h (Figure 13). In this scenario, vehicles are present at the cell edge of the Macro eNB, and therefore they would be transmitting with lower modulation schemes like QPSK. Therefore a lower throughput value is observed in Macro only configuration. However, in Phantom and Femto based HetNets, vehicles are in the vicinity of some small cells and therefore vehicles would be able to transmit data using higher modulation schemes like 16-QAM and 64-QAM. Another reason for higher throughput values is operation of Phantom and Femto eNBs on a higher frequency band (Table 1). However, Phantom based HetNets yield even higher throughput than Femto based HetNets. This can be attributed to the fact that there are less signaling messages that are exchanged between UEs and the Phantom eNBs during data transfer, which are taken care of by the Macro eNB. Resource block (i.e., a small chunk of the 180 KHz bandwidth in the LTE network) used for MIB (transmitted every 40ms in PBCH), SIB (transmitted every 80ms in PDSCH) are utilized for data transfer in case of Phantom eNB, as this information is transmitted from Macro eNB in Phantom based HetNets.

With the velocity of 3 km/h and simulation running time of 100sec as shown in Table 1, each vehicle would travel a distance of 80m. In that case, there would be 2 handovers for every vehicle in both Femto and Phantom based HetNets. Handover in Femto based HetNets involve shift of both control and data planes. However in Phantom based HetNets, it is a

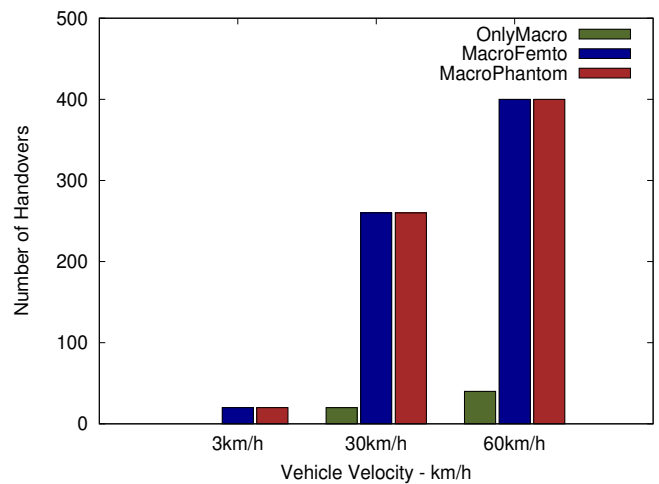


Figure 15. Number of Handovers in different experimental configurations.

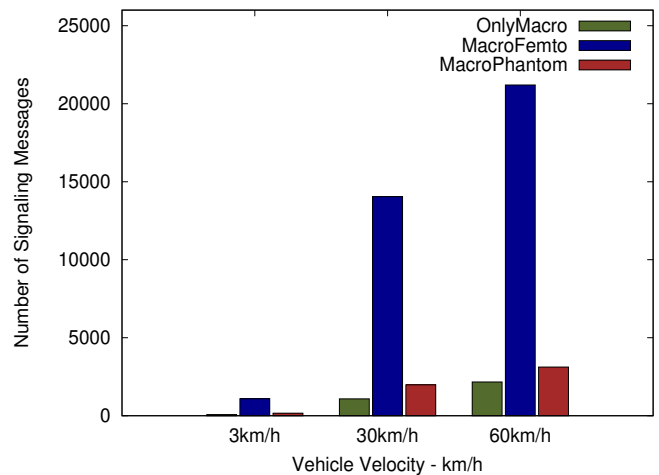


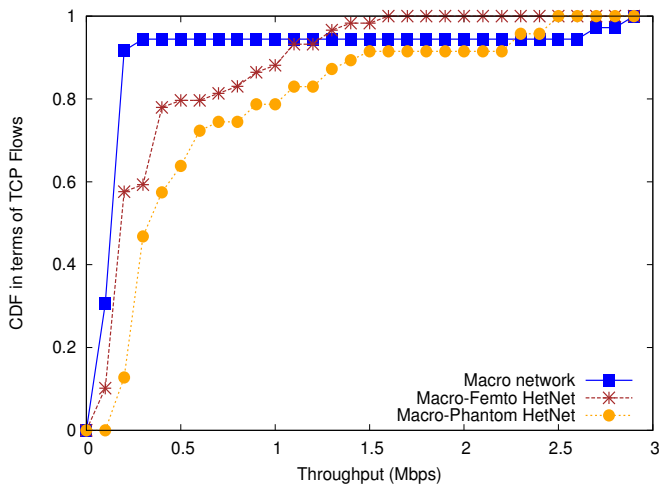
Figure 16. Number of Signaling Messages in different experimental configurations.

mere shift of data plane from one Phantom eNB to the other. Overheads in handovers contribute further to the difference in the system throughput between Femto and Phantom based HetNets.

A decrease in throughput (Figure 13) and an increase in delay (Figure 14) is observed in all the three configurations as the vehicle velocity increases from 3 km/h to 30 km/h and then to 60 km/h. In Macro only configuration, there is a slight dip in throughput values (Figure 13) and accordingly increase in delays are observed. Prime reason for low throughput in Macro only configuration is the large distance of vehicles from Macro eNB and therefore the use of lower modulation schemes. As vehicles move with higher velocity, number of handover increases (Figure 15).

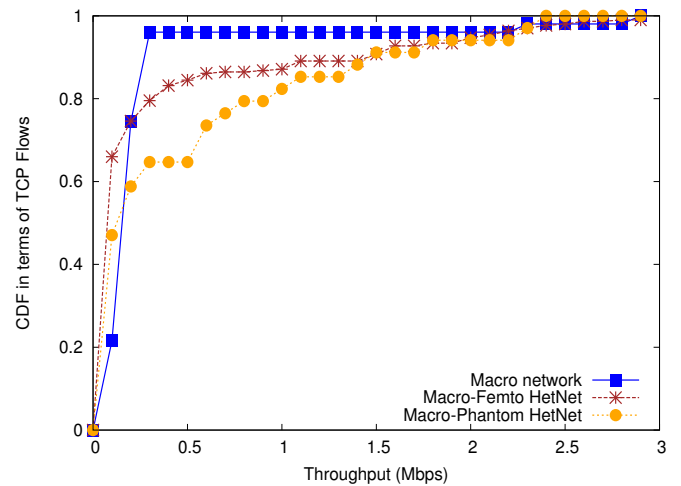
Overheads in handover is another major reason which results in the throughput reduction.

For Phantom and Femto HetNets a comparatively larger reduction is observed in throughput values. This is justified from the experimental setup where in the region of +y axis we have a heterogeneous deployment of eNBs while in -y axis we have only Macro coverage. Initially during the start of simulation all vehicles would lie within the coverage of Macro eNB 3 (refer network configurations in the previous subsection). Now half of them are moving in the direction of +y axis while the remaining half in the direction of -y axis. In that case on the basis of initial vehicle location and their velocity of 3 km/h and 30 km/h, it could be concluded that they would be in coverage of some small cells. However, in the case of 30 km/h number of handovers increases drastically as shown in Figure 15 for Femto and Phantom HetNets. Femto HetNets have a lesser throughput primarily due to lot of signaling overhead (Figure 16). But for the Phantom HetNets there is a centralized Macro eNB controlling the handover mechanism and there is mere shift of data plane from one Phantom eNB to other. Apart from MIB, SIB and handover messages like RRC\_Connected(), RRC\_Disconnected(), RRC\_Idle() are transmitted through Macro eNB instead of Phantom eNB. This reduces the signaling overheads in Phantom HetNets in comparison to Femto HetNets as illustrated in Figure 16.

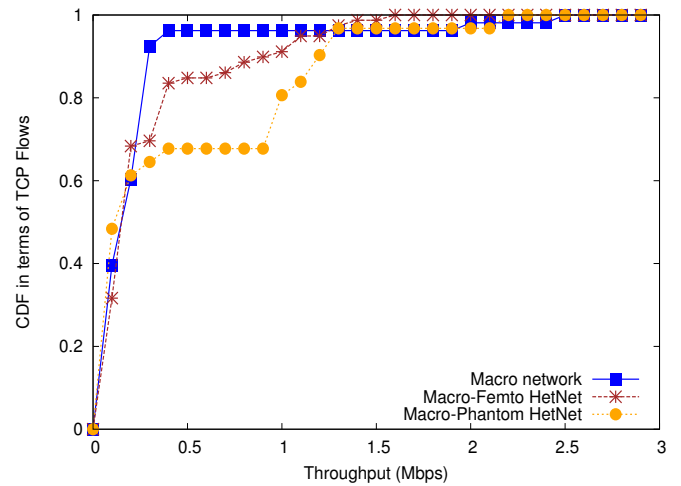


**Figure 17.** CDF for different network configurations with Vehicle Velocity: 3 km/h.

Now for the velocities of 60 km/h vehicles moving in the direction of -y axis would not observe any small cells near by, in configuration (b), (c) and would thus get attached to Macro eNBs numbered 4 or 5. Absence of small cells in the -y axis results in a drop of average throughput of flows for both Phantom and Femto HetNets. Handover overheads for the region in +y axis do exist as in the case of 30 km/h and moreover



**Figure 18.** CDF for different network configurations with Vehicle Velocity: 30 km/h.



**Figure 19.** CDF for different network configurations with Vehicle Velocity: 60 km/h.

handovers take place in the region of -y axis due to higher velocity and thus larger distance being travelled by the vehicles.

Figures 17, 18, 19 represents the CDF (Cumulative Distribution Function) of flows throughput at vehicle velocities of 3 km/h, 30 km/h and 60 km/h respectively. In each of the figures, CDF values for different network configurations (Macro only network, Femto based HetNets and Phantom based HetNets) are plotted. For the Macro only network, we observe that roughly 90% of the flows get a throughput value less than 0.5 Mbps in all the three cases (Figures 17, 18, 19). However this is not observed in case of Femto and Phantom based HetNets. For the vehicle velocity of 3 km/h (Figure 17), in case of Femto based HetNets, 98% of the flows have throughput value of 1.5 Mbps

while in case of Phantom based HetNets 90% of the flows have throughput value of 1.5 Mbps. Improvement in flow throughput values in Femto and Phantom based HetNets as compared to Macro only network is basically due to the presence of vehicles at cell edges in Macro only network. Now if there are small cells deployed at cell edges more flows get a better throughput as can be seen from Figure 17. However significant improvement is not observed as not all the vehicles are in the coverage of small cells because of their initial location in experiment configuration and also since they are moving with the velocity of 3 km/h only.

From the CDF graph in Figure 18 for 30 km/h velocity, we can observe that nearly 83% of the flows achieves 1 Mbps throughput in Femto based HetNets and 78% of the flows achieve 1 Mbps throughput in Phantom based HetNets. This means that there are more number of flows with a higher throughput value in comparison with Macro only network as Macro only network has 90% of the flows with throughput of 0.5 Mbps. Although with the velocity of 30 km/h there are signaling overheads involved in handovers but since the number of handovers are less, signaling overheads are few. Phantom based HetNets yield a further better result in comparison with Femto based HetNets due to centralized Macro eNB controlling the handover mechanism and there is mere shift of D-plane from one PeNB to another.

From the CDF graph in Figure 19 for 60 km/h velocity, it is evident that 83% of the flows achieve 1 Mbps in Femto based HetNets and 65% of the flows achieve 1 Mbps in Phantom based HetNets. Comparing this with CDF plot of Macro only network at 60 km/h we can conclude that these HetNets yield better throughput value for the flows. Phantom based HetNets however perform better in comparison with Femto based HetNets, since at the velocity of 60 km/h, number of handovers increases significantly. Due to the shift of both C-plane and D-plane during handover in Femto based HetNets, signaling overheads are more in this HetNets as compared to Phantom based HetNets which involve shift of mere D-plane.

## 7. Conclusions and Future Work

In this work, mechanisms were designed for splitting the control and data planes among Macro and Phantom eNBs in LTE. Architectural modifications were made in the UE protocol stack to facilitate operation at dual bands. Information exchange between Phantom and Macro eNB over the X2 interface was facilitated. Application use case of Phantom HetNet for Vehicular IoT was illustrated along the course of paper and analyzed through simulations results. An improvement of 80% is observed in throughput value for Phantom based HetNet in comparison with *Macro-only* network

and an improvement of 14% is observed in comparison with Femto based HetNet. Thus we can conclude that Phantom based HetNets are beneficial in outdoor applications like Vehicular IoT.

Load balancing among Phantom eNBs is one of the interesting and challenging aspects for further work. Real-world scenarios may arise where in due to heavy road traffic jams, certain Phantom eNBs may be heavily loaded. Under such cases load balancing could distribute the load among nearby Phantom eNBs. Optimization can be included in handover algorithm, through which unnecessary handovers among small cells could be avoided while vehicles are moving at very high velocities.

**Acknowledgement.** This work was supported by the Deity, Govt of India (Grant No. 13(6)/2010CC&BT).

## References

- [1] L. Atzori, A. Iera, and G. Morabito, "The internet of things: A survey," *Computer networks*, vol. 54, no. 15, pp. 2787–2805, 2010.
- [2] A. Moschitta and I. Neri, "Power consumption assessment in wireless sensor networks," *ICT-Energy-Nanoscale Energy Management Concepts Towards Zero-Power Information and Communication Technology. InTech*, accepted for publication, 2014.
- [3] P. Vlacheas, R. Giuffreda, V. Stavroulaki, D. Kelaidonis, V. Foteinos, G. Poullos, P. Demestichas, A. Somov, A. R. Biswas, and K. Moessner, "Enabling smart cities through a cognitive management framework for the internet of things," *Communications Magazine, IEEE*, vol. 51, no. 6, pp. 102–111, 2013.
- [4] M. Paschou, E. Sakkopoulos, E. Sourla, and A. Tsakalidis, "Health internet of things: Metrics and methods for efficient data transfer," *Simulation Modelling Practice and Theory*, vol. 34, pp. 186–199, 2013.
- [5] L. Mainetti, L. Patrono, and A. Vilei, "Evolution of wireless sensor networks towards the internet of things: A survey," in *Software, Telecommunications and Computer Networks (SoftCOM), 2011 19th International Conference on*, pp. 1–6, IEEE, 2011.
- [6] Y. Sui, J. Vihriala, A. Papadogiannis, M. Sternad, W. Yang, and T. Svensson, "Moving cells: a promising solution to boost performance for vehicular users," *Communications Magazine, IEEE*, vol. 51, no. 6, pp. 62–68, 2013.
- [7] S. D. T. Kelly, N. K. Suryadevara, and S. C. Mukhopadhyay, "Towards the implementation of iot for environmental condition monitoring in homes," *Sensors Journal, IEEE*, vol. 13, no. 10, pp. 3846–3853, 2013.
- [8] M. T. Lazarescu, "Design of a wsn platform for long-term environmental monitoring for iot applications," *Emerging and Selected Topics in Circuits and Systems, IEEE Journal on*, vol. 3, no. 1, pp. 45–54, 2013.
- [9] C. Campolo, A. Iera, A. Molinaro, S. Y. Paratore, and G. Ruggieri, "Smartcar: An integrated smartphone-based platform to support traffic management applications," in *Vehicular Traffic Management for Smart Cities (VTM), 2012 First International Workshop on*, pp. 1–6, IEEE, 2012.

- [10] "Cisco Report." [http://www.cisco.com/c/en/us/solutions/collateral/service-provider/visual-networking-index-vni/white\\_paper\\_c11-520862.html](http://www.cisco.com/c/en/us/solutions/collateral/service-provider/visual-networking-index-vni/white_paper_c11-520862.html).
- [11] "Views on rel-12 and onwards for lte and umts." Future Radio in 3GPP, Huawei Technologies, 2012.
- [12] "IDC Report." <http://www.idc.com/analysts/moreanalystresearch.jsp?containerId=PRF004219&selDocumentType=All&selAccess=All>.
- [13] V. Chandrasekhar, J. G. Andrews, and A. Gatherer, "Femtocell networks: a survey," *Communications Magazine, IEEE*, vol. 46, no. 9, pp. 59–67, 2008.
- [14] V. Sathya, A. Ramamurthy, and B. Reddy, "On placement and dynamic power control of femtocells in lte hetnets," in *GLOBECOM*, IEEE, 2014.
- [15] G. Araniti, C. Campolo, M. Condoluci, A. Iera, and A. Molinaro, "Lte for vehicular networking: a survey," *Communications Magazine, IEEE*, vol. 51, no. 5, pp. 148–157, 2013.
- [16] M. Kihl, K. Bur, P. Mahanta, and E. Coelingh, "3gpp lte downlink scheduling strategies in vehicle-to-infrastructure communications for traffic safety applications," in *Computers and Communications (ISCC), 2012 IEEE Symposium on*, pp. 000448–000453, IEEE, 2012.
- [17] H. Ishii, Y. Kishiyama, and H. Takahashi, "A novel architecture for lte-b: C-plane/u-plane split and phantom cell concept," in *Globecom Workshops (GC Wkshps), 2012 IEEE*, pp. 624–630, IEEE, 2012.
- [18] "3gpp," in *Release 12: Study on small cell enhancements for E-UTRA and E-UTRAN*.
- [19] H. Lokhandwala, V. Sathya, and B. R. Tamma, "Phantom cell realization in lte and its performance analysis," in *Advanced Networks and Telecommunications Systems (ANTS), 2014 IEEE International Conference on*, pp. 1–6, IEEE, 2014.
- [20] H. Zhang, W. Ma, W. Li, W. Zheng, X. Wen, and C. Jiang, "Signalling cost evaluation of handover management schemes in lte-advanced femtocell," in *Vehicular Technology Conference (VTC Spring), 2011 IEEE 73rd*, pp. 1–5, IEEE, 2011.
- [21] B. Sas, K. Spaey, and C. Blondia, "Classifying users based on their mobility behaviour in lte networks," in *ICWMC 2014, The Tenth International Conference on Wireless and Mobile Communications*, 2014.
- [22] A. Bousia, E. Kartsakli, L. Alonso, and C. Verikoukis, "Energy efficient base station maximization switch off scheme for lte-advanced," in *Computer Aided Modeling and Design of Communication Links and Networks (CAMAD), 2012 IEEE 17th International Workshop on*, pp. 256–260, IEEE, 2012.
- [23] I. Ashraf, F. Boccardi, and L. Ho, "Sleep mode techniques for small cell deployments," *Communications Magazine, IEEE*, vol. 49, no. 8, pp. 72–79, 2011.
- [24] "Qualcomm." <https://www.qualcomm.com/invention/technologies/lte/lte-carrier-aggregation>.
- [25] "3GPP." <http://www.3gpp.org/technologies/keywords-acronyms/101-carrier-aggregation-explained>.
- [26] "3rd Generation Partnership Project; Technical Specification Group Radio Access Network; Study on Small Cell enhancements for E-UTRA and E-UTRAN; Higher layer aspects ,TS 36.842 V12.0.0,Jan. 2014." <http://www.3gpp.org/releases>.
- [27] D. Xenakis, N. Passas, L. Merakos, and C. Verikoukis, "Mobility management for femtocells in lte-advanced: key aspects and survey of handover decision algorithms," *Communications Surveys & Tutorials, IEEE*, vol. 16, no. 1, pp. 64–91, 2014.
- [28] A. Ulvan, R. Bestak, and M. Ulvan, "Handover scenario and procedure in lte-based femtocell networks," in *UBICOMM 2010, The Fourth International Conference on Mobile Ubiquitous Computing, Systems, Services and Technologies*, pp. 213–218, 2010.
- [29] L. Wang, Y. Zhang, and Z. Wei, "Mobility management schemes at radio network layer for lte femtocells," in *Vehicular Technology Conference, 2009. VTC Spring 2009. IEEE 69th*, pp. 1–5, IEEE, 2009.
- [30] "NS-3 Simulator." <https://www.nsnam.org/>.
- [31] T. Nakamura, S. Nagata, A. Benjebbour, Y. Kishiyama, T. Hai, S. Xiaodong, Y. Ning, and L. Nan, "Trends in small cell enhancements in lte advanced," *Communications Magazine, IEEE*, vol. 51, no. 2, pp. 98–105, 2013.
- [32] J.-c. Zhao, J.-f. Zhang, Y. Feng, and J.-x. Guo, "The study and application of the iot technology in agriculture," in *Computer Science and Information Technology (ICCSIT), 2010 3rd IEEE International Conference on*, vol. 2, pp. 462–465, IEEE, 2010.